

GP2L09/GP2L24 GP2L26

Subminiature, High Sensitivity Photointerrupter

■ Features

1. Compact and thin
 - GP2L09**: Compact DIP, long lead type
 - GP2L24**: Compact DIP type
 - GP2L26**: Flat lead type
2. Optimum detection distance: 0.6 to 0.8mm
3. High sensitivity
(I_C : MIN. 0.5mA at $I_F = 4mA$)
4. Visible light cut-off type

■ Applications

1. Cassette tape recorders, VCRs
2. Floppy disk drives
3. Various microcomputerized control equipment

■ Outline Dimensions

(Unit : mm)

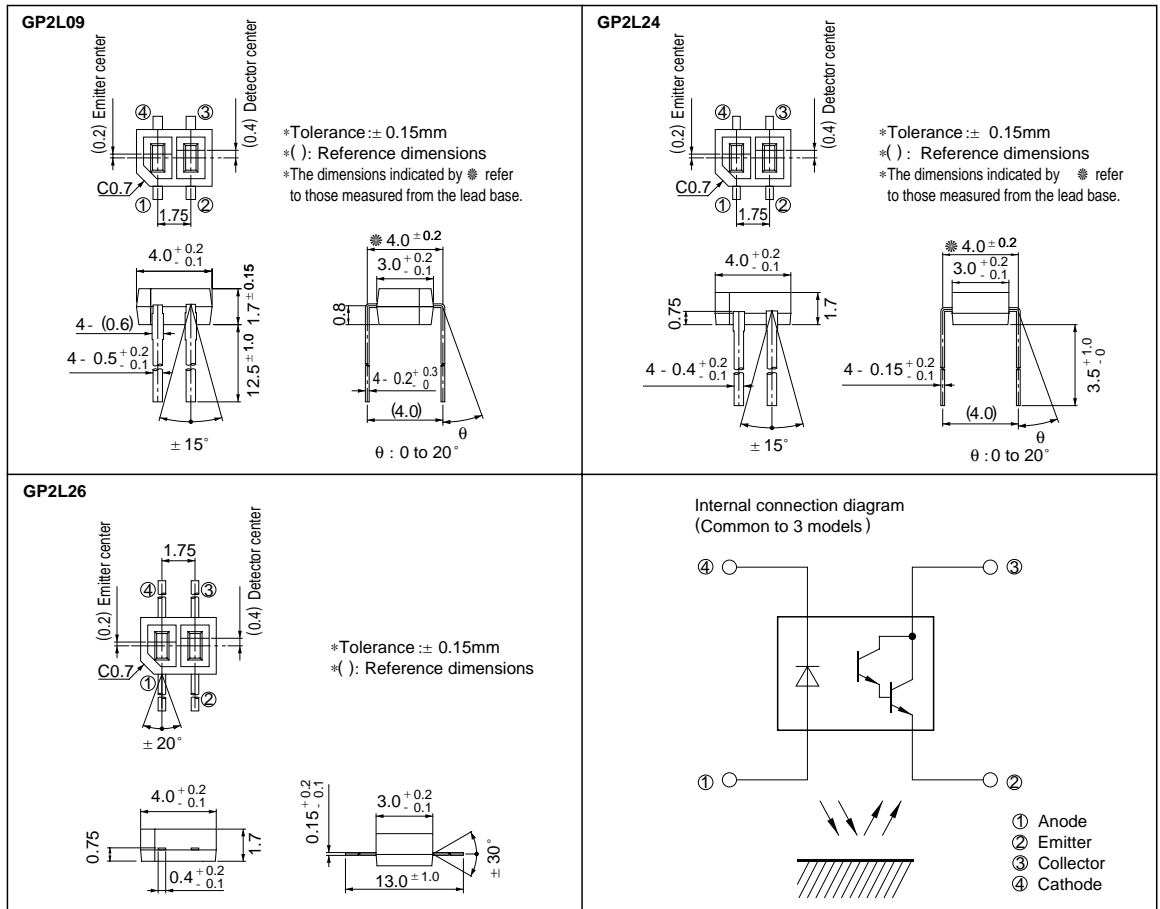

Absolute Maximum Ratings

(Ta = 25°C)

	Parameter	Symbol	Rating	Unit
Input	Forward current	I _F	50	mA
	Reverse voltage	V _R	6	V
	Power dissipation	P	75	mW
Output	Collector-emitter voltage	V _{CEO}	35	V
	Emitter-collector voltage	V _{ECO}	6	V
	Collector current	I _C	50	mA
	Collector power dissipation	P _C	75	mW
	Total power dissipation	P _{tot}	100	mW
	Operating temperature	T _{opr}	- 25 to + 85	°C
	Storage temperature	T _{stg}	- 40 to + 100	°C
	*1 Soldering temperature	T _{sol}	260	°C

*1 Within 5 seconds (Soldering areas for each model are shown below.)

GP2L09, GP2L24

Soldering area

The hatched area more than 1mm^{*2} away from the lower edge of package as shown in the drawing below.

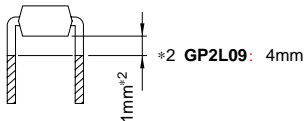

GP2L26

Soldering area

The hatched area more than 2.0mm away from the both edge of package as shown in the drawing below.

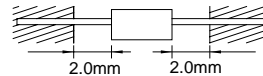

Electro-optical Characteristics

(Ta = 25°C)

	Parameter	Symbol	Conditions	MIN.	TYP.	MAX.	Unit	
Input	Forward voltage	I _F	I _F = 20mA	-	1.2	1.4	V	
	Reverse current	I _R	V _R = 6V	-	-	10	μA	
Output	Collector dark current	I _{CEO}	V _{CE} = 10V, I _F = 0	-	-	1 × 10 ⁻⁶	A	
Transfer-characteristics	*3 Collector current	I _C	V _{CE} = 2V, I _F = 4mA	0.5	3.0	15.0	mA	
	Response time	Rise time	t _r	V _{CE} = 2V, I _C = 10mA R _L = 100Ω, d = 1mm	-	80	400	μs
		Fall time	t _f		-	70	400	μs
	*4 Leak current	I _{LEAK}	I _F = 4mA, V _{CE} = 5V	-	-	5.0	μA	

*3 The condition and arrangement of the reflective object are shown in the right drawing.

*4 Without reflective object

The ranking of collector current shall be classified into the following 6 ranks.

(GP2L09, GP2L24, GP2L26)

Rank	Collector current I _C (mA)
*5 A	0.5 to 1.9
B	1.45 to 5.4
C	4.0 to 15.0
A or B	0.5 to 5.4
B or C	1.45 to 15.0
A, B or C	0.5 to 15.0

*5 GP2L24 and GP2L26 don't have A rank.

Test Condition for Collector Current

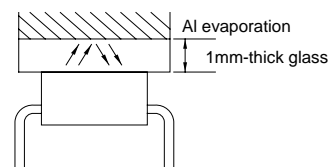

Fig. 1 Forward Current vs. Ambient Temperature

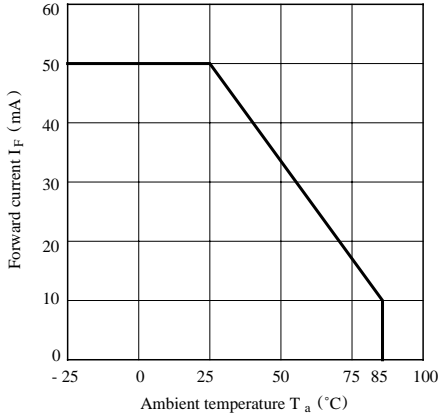

Fig. 2 Power Dissipation vs. Ambient Temperature

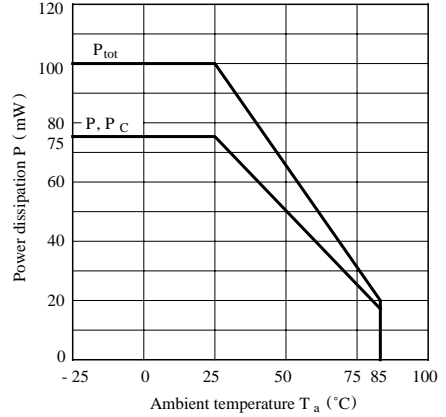

Fig. 3 Peak Forward Current vs. Duty Ratio

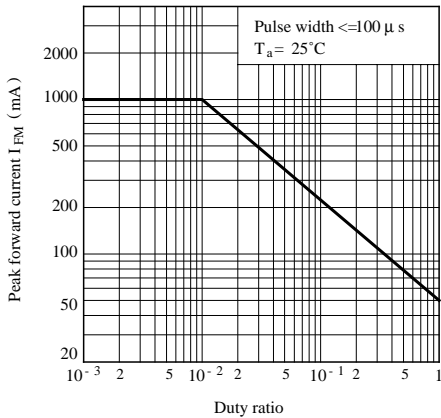

Fig. 4 Forward Current vs. Forward Voltage

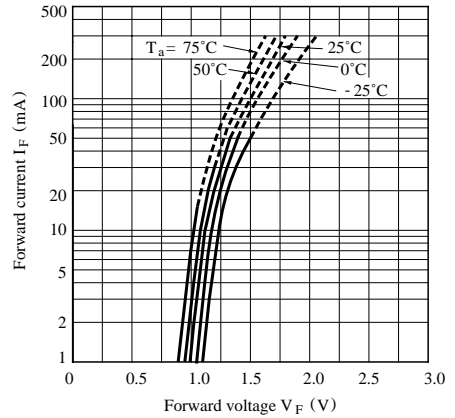

Fig. 5 Collector Current vs. Forward Current

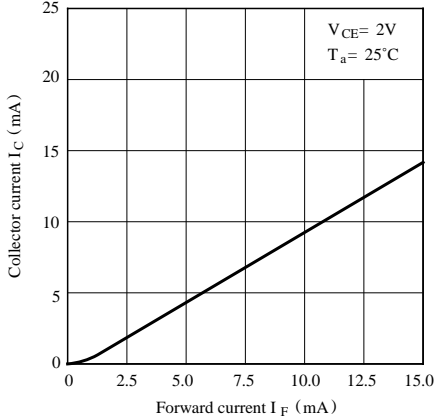

Fig. 6 Collector Current vs. Collector-emitter Voltage

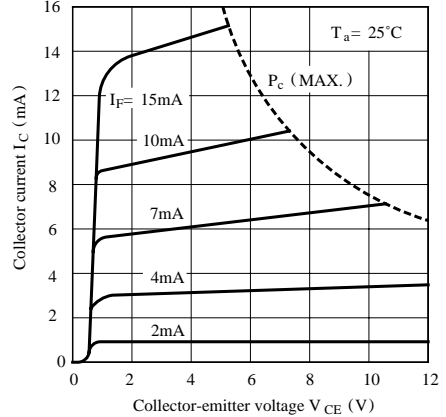

Fig. 7 Relative Collector Current vs. Ambient Temperature

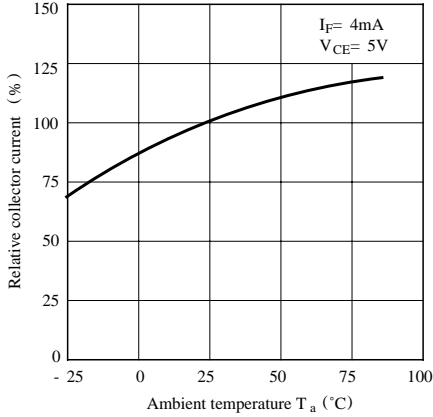

Fig. 8 Collector Dark Current vs. Ambient Temperature

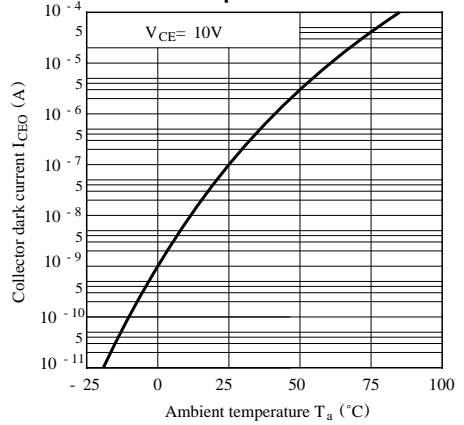

Fig. 9-a Response Time vs. Load Resistance (GP2L09)

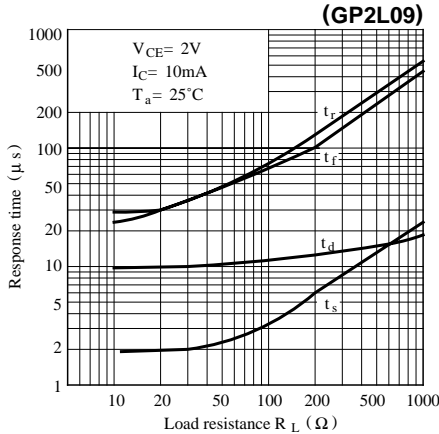

Fig. 9-b Response Time vs. Load Resistance (GP2L24/GP2L26)

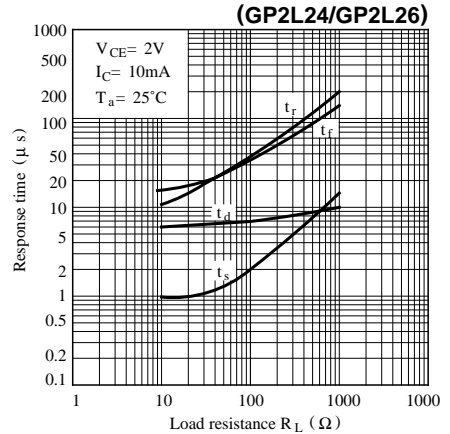
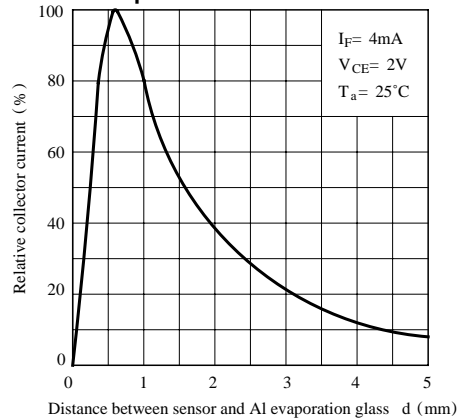

Fig.10 Relative Collector Current vs. Distance between Sensor and Al Evaporation Glass



Test Circuit for Response Time

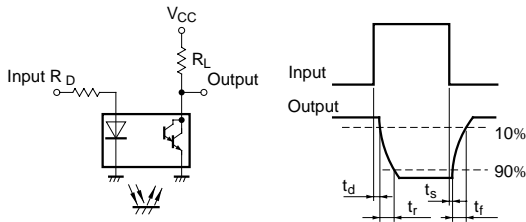

Fig.11 Relative Collector Current vs. Card Moving Distance (1)

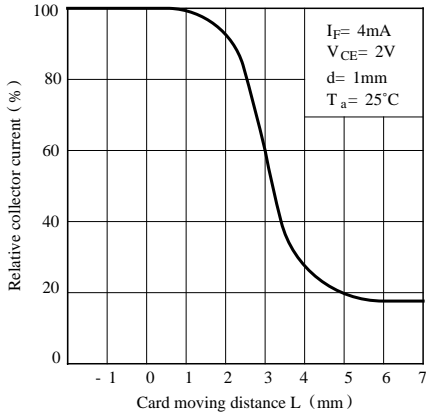
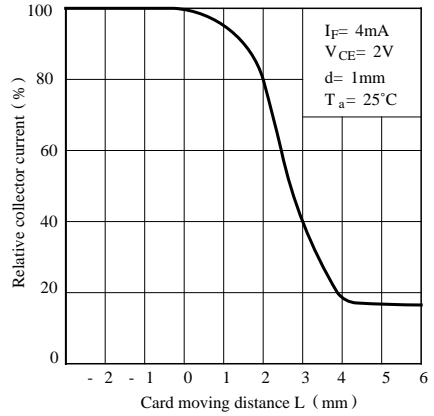

Fig.12 Relative Collector Current vs. Card Moving Distance (2)



Test Condition for Distance & Detecting Position Characteristics

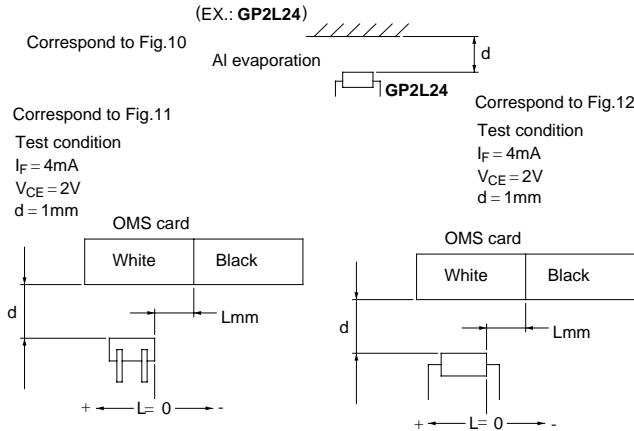

Fig.13 Frequency Response (GP2L09)

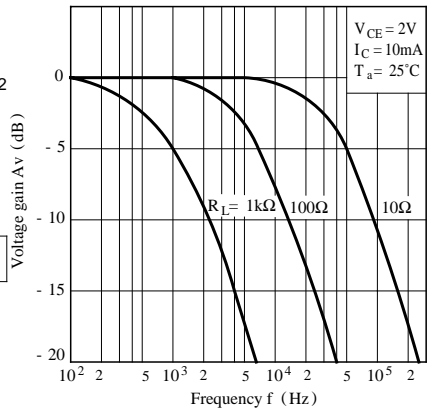

Fig.14 Frequency Response (GP2L24/ GP2L26)

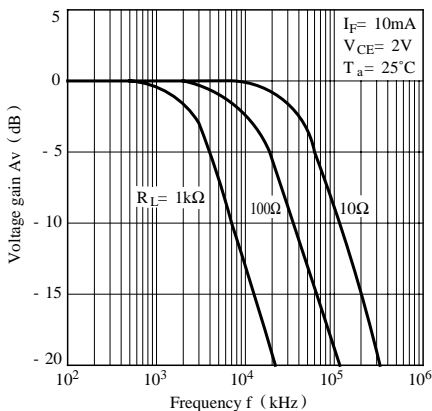
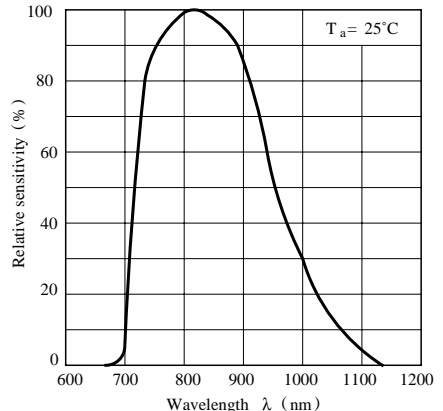

Fig.15 Spectral Sensitivity (Detecting Side)



■ Precautions for Use

- (1) In order to stabilize power supply line, connect a by-pass capacitor of more than 0.01 μ F between Vcc and GND near the device.
 - (2) In this product, the PWB is fixed with a resin cover, and cleaning solvent may remain inside the case; therefore, dip cleaning or ultrasonic cleaning are prohibited.
 - (3) Remove dust or stains, using an air blower or a soft cloth moistened in cleaning solvent. However, do not perform the above cleaning using a soft cloth with cleaning solvent in the marking portion.
In this case, use only the following type of cleaning solvent used for wiping off:
Ethyl alcohol, Methyl alcohol, Isopropyl alcohol, Freon TE, Freon TF, Diflon solvent S3-E
When the cleaning solvents except for specified materials are used, please consult us.
 - (4) As for other general cautions, refer to the chapter “Precautions for Use”.
-

NOTICE

- The circuit application examples in this publication are provided to explain representative applications of SHARP devices and are not intended to guarantee any circuit design or license any intellectual property rights. SHARP takes no responsibility for any problems related to any intellectual property right of a third party resulting from the use of SHARP's devices.
- Contact SHARP in order to obtain the latest device specification sheets before using any SHARP device. SHARP reserves the right to make changes in the specifications, characteristics, data, materials, structure, and other contents described herein at any time without notice in order to improve design or reliability. Manufacturing locations are also subject to change without notice.
- Observe the following points when using any devices in this publication. SHARP takes no responsibility for damage caused by improper use of the devices which does not meet the conditions and absolute maximum ratings to be used specified in the relevant specification sheet nor meet the following conditions:
 - (i) The devices in this publication are designed for use in general electronic equipment designs such as:
 - Personal computers
 - Office automation equipment
 - Telecommunication equipment [terminal]
 - Test and measurement equipment
 - Industrial control
 - Audio visual equipment
 - Consumer electronics
 - (ii) Measures such as fail-safe function and redundant design should be taken to ensure reliability and safety when SHARP devices are used for or in connection with equipment that requires higher reliability such as:
 - Transportation control and safety equipment (i.e., aircraft, trains, automobiles, etc.)
 - Traffic signals
 - Gas leakage sensor breakers
 - Alarm equipment
 - Various safety devices, etc.
 - (iii) SHARP devices shall not be used for or in connection with equipment that requires an extremely high level of reliability and safety such as:
 - Space applications
 - Telecommunication equipment [trunk lines]
 - Nuclear power control equipment
 - Medical and other life support equipment (e.g., scuba).
- Contact a SHARP representative in advance when intending to use SHARP devices for any "specific" applications other than those recommended by SHARP or when it is unclear which category mentioned above controls the intended use.
- If the SHARP devices listed in this publication fall within the scope of strategic products described in the Foreign Exchange and Foreign Trade Control Law of Japan, it is necessary to obtain approval to export such SHARP devices.
- This publication is the proprietary product of SHARP and is copyrighted, with all rights reserved. Under the copyright laws, no part of this publication may be reproduced or transmitted in any form or by any means, electronic or mechanical, for any purpose, in whole or in part, without the express written permission of SHARP. Express written permission is also required before any use of this publication may be made by a third party.
- Contact and consult with a SHARP representative if there are any questions about the contents of this publication.